

RDF-10
RADIO DIRECTION
FINDER

**TECHNICAL
DESCRIPTION
AND
OPERATING
INSTRUCTIONS**

HAMMARLUND

The Hammarlund Manufacturing Co., Inc.
460 West 34th Street, New York 1, N. Y.

International Division: 13 East 40th Street, New York 16, N. Y.

<i>Page</i>		
1	FIGURE 1 -	PHOTO-FRONT VIEW RDF-10
2	FIGURE 2 -	TYPICAL INSTALLATION*
5	FIGURE 3 -	METHODS OF OBTAINING A BEARING
6	FIGURE 4 -	STEP BY STEP BEARING ILLUSTRATION
8	FIGURE 5 -	DEVIATION CHART
8	FIGURE 6 -	BATTERY REPLACEMENT
1	FIGURE 8 -	RF COILS LOCATION
1	FIGURE 9 -	RF TRIMMER LOCATION
1	FIGURE 10 -	DIAL CORD ASSEMBLY
2	FIGURE 11 -	SCHEMATIC DIAGRAM
2	FIGURE 12 -	STATION LOG

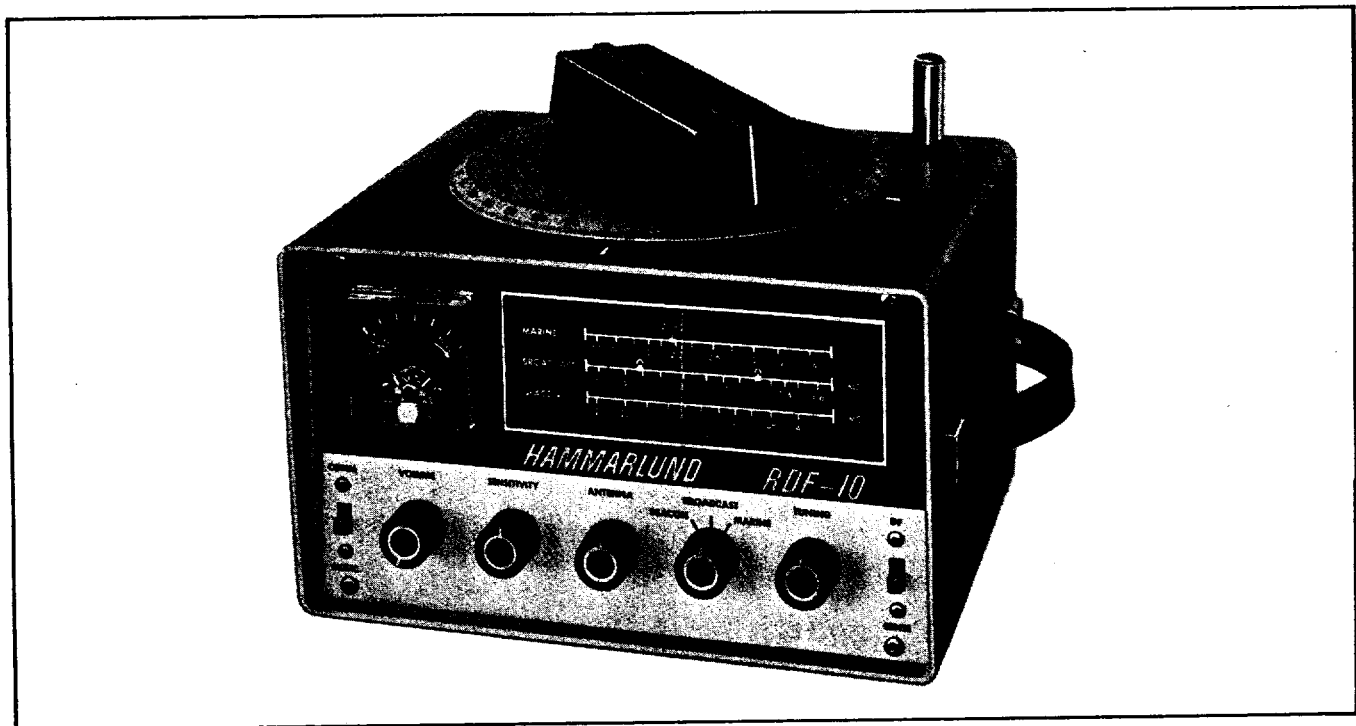

Figure 1. Front View RDF10

INTRODUCTION

The Hammarlund RDF-10 is a portable, transistorized, Radio Direction Finder, and Radio Receiver. The RDF-10 is designed to provide bearings for location of the craft on which it is used, for entertainment, and for monitoring the 2182 Kc distress frequency when the radio telephone is active and the craft is under way. Conelrad frequencies for information during enemy attack are marked by the CD emblem at two points in the broadcast band. Consolan (long range navigational aid) is indicated by the letter "C" near .19 Mc.

A unique feature of the RDF-10 is the inclusion of a calibrated but unmarked compass scale fixed to the top of the cabinet. This scale provides a rapid method of finding any deviation called quadrature error in RDF bearings due to metallic objects

or super-structures on the particular craft on which the unit is operated. This method of calibration is and has been standard on ocean going vessels since the first years of radio direction finding.

To the discriminating skipper this means he can approach the harbor of his choice with assurance that his position will be within 184 ft. at 1 mile based on a maximum error of 2°.

A 10° error at 1 mile would be .18 miles and at 10 miles would be 1.8 miles. These errors do not include wind and tide.

The Hammarlund RDF-10 was designed with the small craft user in mind and will provide many happy hours of boating free from fear of weather conditions and/or darkness provided the installation and operating instructions are carefully followed.



INSTALLATION

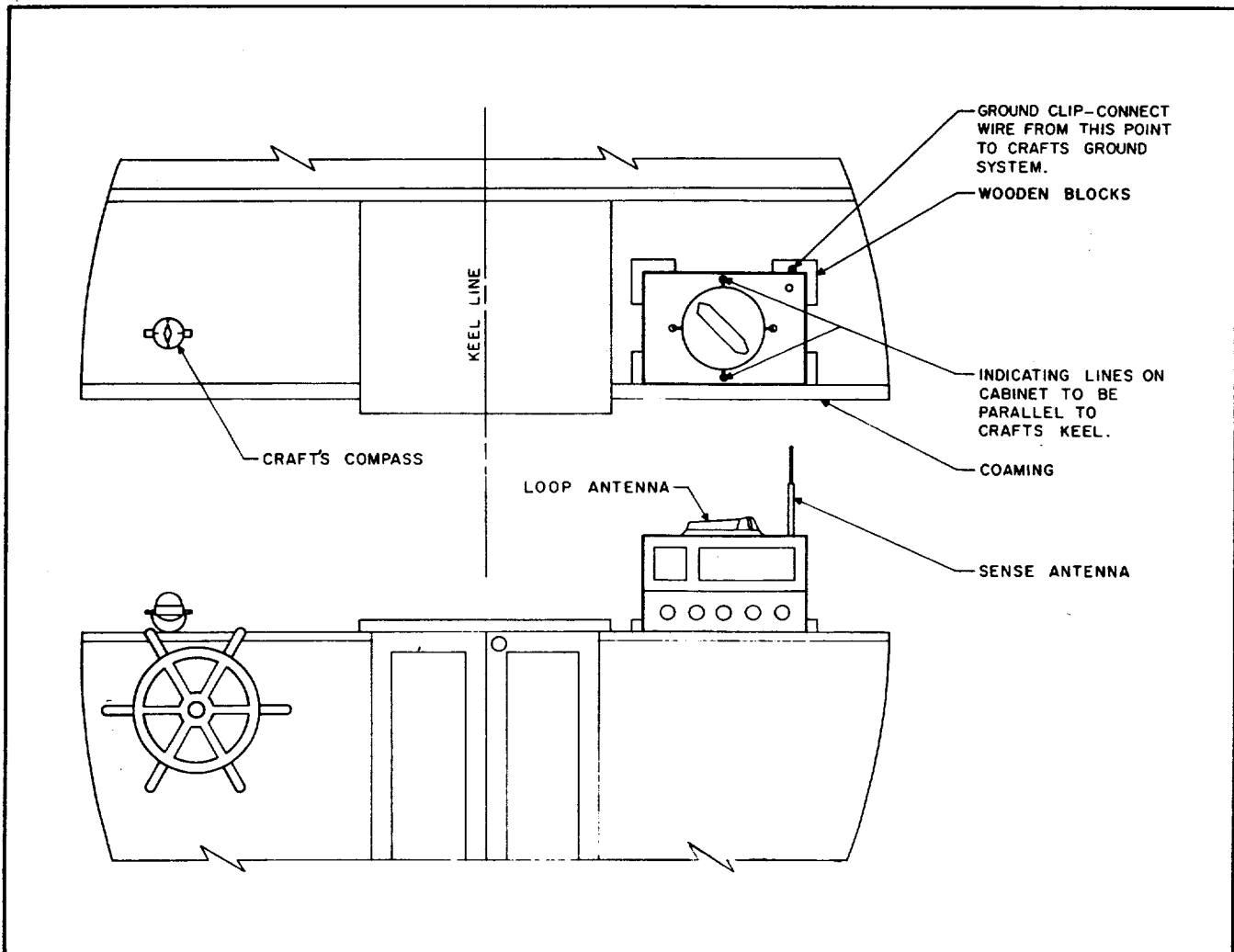

Figure 2. Typical Installation*

The Hammarlund RDF-10 should be installed in a convenient operating position aboard the vessel. Care must be taken to keep the unit clear of the craft's compass and overhead metallic structures.

The loudspeaker magnet of this unit if too close will affect the craft's compass, while overhead metallic wiring or structures may affect the bearings taken with the RDF-10.

Figure 2 illustrates a typical installation:

**Unit should be a minimum of 3 feet from magnetic compass.*

For convenience in taking bearings the cabinet should be lined up with the craft's lubber or keel line using the indicator marks as shown in Figure 2. If it is desired to have the front panel of the RDF-10 face 90° from the illustration the other indicator marks may be used to align to the keel line. Once the RDF-10 has been installed make sure all metallic rigging and objects remain in the same position after calibration. (Refer to Page 7 for Calibration instructions).



Description

The RDF-10 is completely self-contained including a sense antenna allowing uni-directional bearings to be determined.

The features of the RDF-10 are listed as follows:
Three Bands – Radio Beacon, Broadcast and Marine

Null Meter – For Visual Bearings

Shielded Ferrite Loop – For Sensitive Signal Pick-up and accurate direction finding.

Sense Antenna – For Single Direction Bearings

Power Supply – 6 size “C” or #1 Flashlight Batteries

10 Transistors – Maximum Sensitivity and Selectivity

Superhetrodyne

Tone Generator – For receiving continuous wave signals and aiding in null indication.

Front Panel Controls

A. Comm-Music – “Comm” Position provides tone for receiving continuous wave signals.

- B. Off-Volume – Unit Off-On and Loudspeaker Volume
- C. Sensitivity – Controls Deflection of Null Meter for RDF bearing and sensitivity for entertainment
- D. Antenna – Rotates Antenna
- E. Band – Selects Beacon, Broadcast, or Marine
- F. Tuning – Slides Dial Pointer to Desired Frequency
- G. DF-Sense – For RDF Bearings
- H. – A Phone Jack for using standard, low impedance (4 to 30 ohms) earphones in noisy locations is located above the loudspeaker.

Band Switch

- Beacon – .19 - .4 Mcs (190 - 400 Kc)
Marine direction finding Beacons
285 to 325 Kc
- Broadcast – .55 - 1.6 Mcs (550 - 1600 Kc)
- Marine – 1.7 - 3.4 Mcs (1700 - 3400 Kc)

OPERATION

Basic Operational Steps

CAUTION: DO NOT OPERATE MARINE RADIOTELEPHONE WITH “SENSE” ANTENNA OF RDF - 10 EXTENDED.

Broadcast or Entertainment:

- A. Set MUSIC-COMM Switch to “Music”.
- B. Rotate Sensitivity control clockwise as required.
- C. Select band.
- D. Set DF-Sense switch to “DF” and rotate loop for maximum signal.
- E. Rotate volume control to two-thirds full clockwise position.
- F. Select frequency or station on dial.
- G. Set volume to desired level after rotating loop antenna for maximum signal.

Radio Direction Finding:

- A. Set MUSIC-COMM Switch to either position. (A tone will appear on the signal in “COMM” position)

- B. Rotate Sensitivity control fully clockwise.
- C. Select band.
- D. Set DF-Sense Switch to “DF”.
- E. Rotate volume control to loudspeaker volume desired.
- F. Tune to desired frequency or station.
- G. Rotate loop for minimum signal and adjust sensitivity control until a definite deflection indication can be seen on the null meter as the loop is turned.
- H. Rotate compass card to line up with ship compass.
- I. You are now ready to take bearings.
- J. The detailed procedure follows the caution notes and general information.



Consolan Direction Finding:

Consolan is essentially a long range navigational aid. There is no special Consolan equipment required. Signals may be received on any low frequency receiver, or any other receiver covering the frequency range and equipped to receive continuous waves. When the loop antenna is used, best results will be obtained in case of severe static by placing the loop near the maximum signal position. If a communications receiver is used the CW tone generator position is employed.

The Consolan System employs a pattern of alternating dot sectors and dash sectors separated by the equisignal. The width of the sectors is about 12° average, but differs slightly, being smallest on the normal to the line of the towers.

Dependent upon the observer's position with respect to the station, various combinations of dots, dashes, and equisignals will be heard. As the pattern rotates, the predominant dot or dash signals will blend into a continuous tone which is the equisignal. The total number of dots and dashes transmitted during a 30-second dot/dash period is 60. The exact change from dots to dashes (or vice-versa) is masked by the equisignal and one or more dots or dashes are lost. The number of lost dots or dashes is obtained by subtracting from 60 the total observed count of dots and dashes. One half of the lost characters are assumed to be dots and the other half dashes. The frequencies in use are 190 Kcs and 194 Kcs.

The methods of obtaining a bearing and charts for Consolan are found in Part VII of U. S. Navy Hydrographic Office Publication No. 205.

Basic Information For Radio Direction Finding:

Caution Notes:

1. The actual location of the transmitter site for stations other than Marine beacons must be known for these bearings to be useful or usable.
2. Broadcast stations will appear much stronger than other stations because they radiate from 100 to 5000 times the power of beacon stations.
3. Use the beacon stations .285 - .325 mc (285 - 325 Kc) for exact bearing and other stations for reference only unless they are listed on the navigational charts.
4. Readings over 50 miles especially at night may prove erroneous.

5. On some stations only an audible null may be taken because the method of transmission causes the meter to fluctuate.

General Information:

The Coast Guard provides three types of radio beacons, a low power (5 miles) usually on river waters or on jettys to inlets, a medium power (20 miles) for intermediate range, and high power (50 miles) for distance finding and direction finding.

Many of the high power beacon stations operate in combinations of 3 on the same frequency and follow each other with a coded signal enabling the operator to establish a fix immediately.

The Mercator navigation charts* contain the location of the beacon stations, their operating time, code, and range.

Weather information may be obtained from commercial radio telephone stations and by listening to the aircraft radio range stations in the beacon band.

Navigational Aids:

Radio Navigational Aids - HO-205 Hydrographic Office Department of the Navy Washington 25, D.C.	\$5.00
Directory of Weather Broadcasts Superintendent of Documents U.S. Government Printing Office Washington 25, D.C.	\$.15

Many of the major oil companies publish marine listings for aircraft and broadcast stations with their frequencies and locations.

*Catalogs

U.S. Coastal Waters, Charts United States Coast and Geodetic Survey Washington 25, D.C.	Free
Mississippi River Mississippi River Commission Corps of Engineers P.O. Box 80 Vicksburg, Mississippi	
Great Lakes Canals, Etc. U.S. Lake Survey 630 Federal Bldg. Detroit 26, Michigan	Free
Canadian Waters Dominion Hydrographer Canadian Hydrographic Service Ottawa, Canada	



DETAILED OPERATION FOR RADIO DIRECTION FINDING:

After the unit has been set up under BASIC OPERATION, STEP accurate bearings are ready to be taken.

STEPS IN IDENTIFYING BEACON OR STATION:

1. Know the frequency.
2. Know the identifying code.
3. Know the time of transmission.
4. Know the location/s.
This information may be obtained from the navigational chart.
5. There may be other beacons on the same frequency from which bearings may be taken by merely rotating the loop.

STEPS IN TAKING A BEARING:

1. Set compass rose on top of RDF-10 to same heading as the craft's compass.
2. Rotate loop until signal is at MAXIMUM both audible and visual (meter to "set sense" direction).
3. Change "Sensitivity" knob until meter pointer is under or toward "set-sense" mark.
4. Rotate loop for MINIMUM both audible and visual (meter to "null" direction).
5. Two maximums and two minimums will be apparent as the loop is rotated. They will be 180 degrees apart.
6. The use of the SENSE antenna is only required when the approximate direction of the station is unknown. Should any doubt exist as to the direction of the station you desire to use to take a bearing or home on, the SENSE antenna becomes very important since this makes it possible to eliminate the 180° ambiguity.

To utilize the SENSE antenna, after tuning in the desired station and obtaining a null with the receiver in the DF switch position, extend the SENSE antenna and switch from DF to the "SENSE" position. Carefully rotate the loop in a clockwise direction while observing the meter carefully. If the meter swings away from NULL or to the left, the white indicator on the loop is pointed in the general direction of the station. If the signal decreases (the meter swings toward NULL or to the right) the station is approximately 180° away from the white indicator. Once the direction of the station has been determined, using the SENSE antenna and the procedure just described, switch to DF to obtain an accurate bearing.

7. Move "DF-Sense" switch to "DF" position and rotate loop for minimum.
8. Check the compass rose against ship's compass and reset rose if necessary.
9. Record bearing reading at minimum that is in same direction as "sense" indicated in step 6.
10. Plot bearing on chart from location of transmitting station with respect to magnetic north.
11. Repeat same procedure on several more stations.
12. The intersection of the lines on the chart indicates your position.

To use RDF-10 as a homing device, find the direction of the station and bring craft to this heading. Rotate loop in "DF" position for minimum or null and follow this course. Check for minimum or null every few minutes in order to make sure wind and tide has not changed your course.

Figure 3 indicates several methods of obtaining a bearing.

Figure 4 step by step illustration for obtaining a "fix".

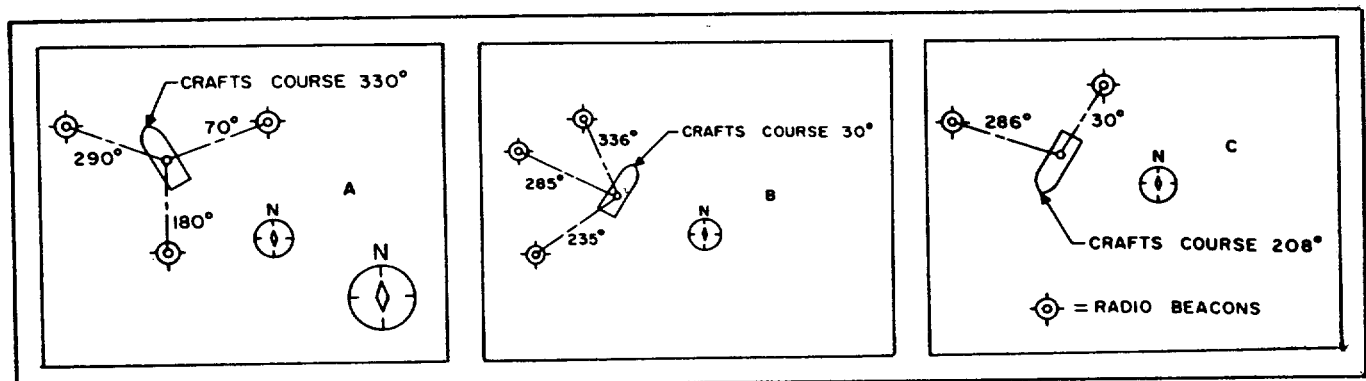

Figure 3. Methods of Obtaining a Bearing

NAVIGATIONAL PROCEDURES WITH THE HAMMARLUND RDF-10

<p>1 READ CRAFTS COMPASS</p> 	<p>2 SET ROSE WITH FORWARD LUBBER LINE TO SHIPS COMPASS READING</p> 	<p>3 TUNE IN BEACON STATION</p> 	<p>4 TUNE FOR NULL AS INDICATED ON METER ...</p> <p style="text-align: right;">BY ROTATING LOOP</p> 
<p>5 LOCATE BEACON STATION ON CHART</p> 	<p>6 SET PARALLEL RULE ON CHART'S ROSE TO DEGREE READING ON RDF ROSE AS INDICATED BY POINTER ON LOOP</p> 	<p>7 RUN PARALLEL RULE OVER BEACON STATION</p> 	<p>BEACON FREQUENCIES ARE .285 TO .325 MC (285 TO 325 K.C)</p> <p>HAMMARLUND MFG. CO. FORM NO. 4293</p>
<p>8 DRAW LINE PROJECTING FROM PARALLEL RULE ACROSS CHART</p> 	<p>9 TUNE IN ANOTHER BEACON STATION AND REPEAT STEPS 4 THRU 8 TO OBTAIN CROSSING LINES AND SHIP'S POSITION</p> 		

Figure 4. Step By Step Bearing Illustration



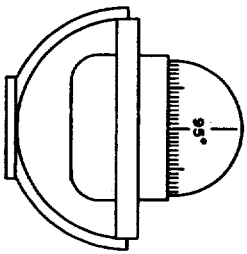
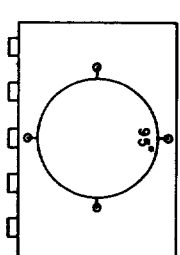
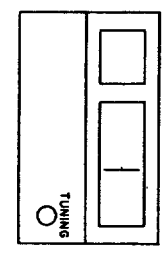
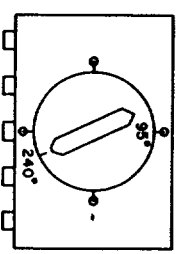
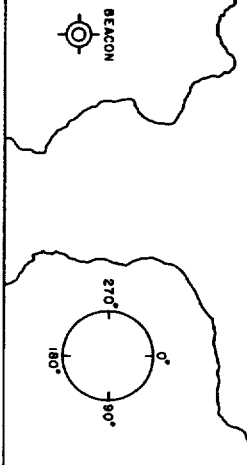
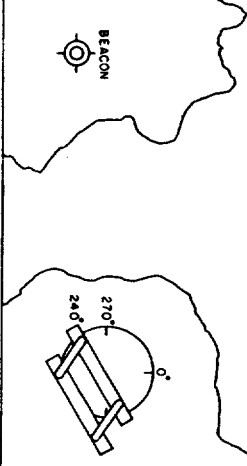
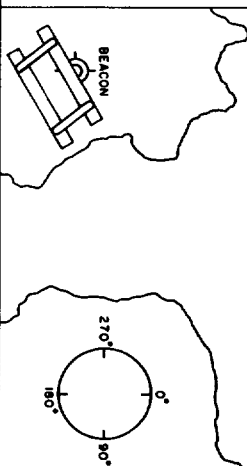
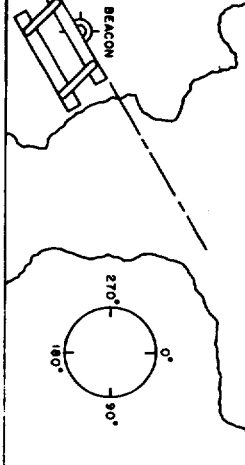
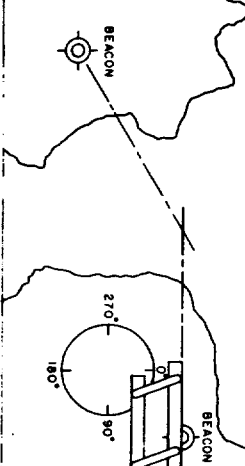

CALIBRATION

Purpose of Calibration

The main reason for calibration of the RDF-10 is to correct the quadrature error of the magnetic fields set up by metallic superstructure, including mast stays, radio-telephone antennas, electrical wiring, etc. around, above and near the unit.

These magnetic fields may be strong enough to affect the operation of a direction finding loop by as much as 10° either positive or negative. Hammarlund through their long years of radio receiver experience, in order to provide a more useful unit, has endeavored to take into account the errors that occur and allow for correction by furnishing the additional white fixed scale for convenience and a chart for plotting any deviations.

The deviations vary within the same types of craft and vary much more with different types of craft.

Each unit should be calibrated on the craft with which it is to be operated.

All metallic super-structure must be in the same position for taking an accurate bearing as they were when the calibration was made.

It should be noted that the broadcast or marine bands are not suitable for accurate direction finding and should be used for reference only.

Procedure for Calibration

The procedure for calibration is similar to taking a bearing except that the transmitting site is in view at all times at a distance of from 2 to 4 miles.

Additional equipment necessary for the calibration is a sight pelorus.

In order to make an accurate calibration an operator for the sight pelorus and another for the RDF-10 are required.

Calibration steps are as follows:

1. Proceed to within 2 to 4 miles of lighthouse beacon transmitting site.
2. Set up RDF-10 for "DF" bearings in BEACON BAND.
3. Line up sight pelorus with keel line of craft and 360° dead ahead.
4. Bring craft about until sight pelorus indicates transmitting site dead ahead.
5. If radio telephone is aboard request lighthouse to transmit steady signal for calibration purposes.*
6. Rotate loop for minimum reading with white marker on loop toward beacon. Record this bearing using white fixed compass points on top of RDF-10. The major compass points on this

scale are shown as circles because the location of the cabinet may be in any one of four positions. The circle at dead ahead may then be considered 360°.

7. Bring the craft about in the port direction until the sight pelorus indicates the beacon station at 10°. Rotate the loop and record the bearing indicated on the white scale.
8. Continue the same procedure for each 10° until 360° is again reached.
9. Plot the 36 readings taken on the deviation chart, figure 5.

For example the readings may appear as follows:

Pelorus	RDF Bearing
0°	0°
10°	12½ +2½
20°	24 +4
30°	34½ +4½
40°	45 +5
50°	55 +5
60°	64½ +4½
70°	74 +4
80°	82½ +2½
90°	90 0
100°	97½ -2½
110°	106 -4
120°	115½ -4½
130°	125 -5

The curve for these example readings are shown as a dotted line on the deviation chart.

10. Thereafter when a "DF" bearing is taken the deviation according to the white scale must be applied to the "DF" bearing. In other words the deviation is a correction for the craft's struction or metallic objects and is referenced to the keel line.

For example refer to figure 3A and note the bearing readings and the craft's course and use the example Pelorus and RDF Bearing readings.

The craft's course is 330°, a beacon station is at 70°. This means the beacon is at 100° (between 330° and 70°), with reference to the keel line therefore 2½° must be added to the 70° to obtain a true bearing of 72½°. The inclusion of the white scale enables a quick determination of the deviation without having to calculate the position of the loop with the keel line.

***NOTE:** Most of the U.S. Coast Guard lighthouse stations may be contacted by radio telephone and will when requested transmit a steady carrier for calibration purposes.

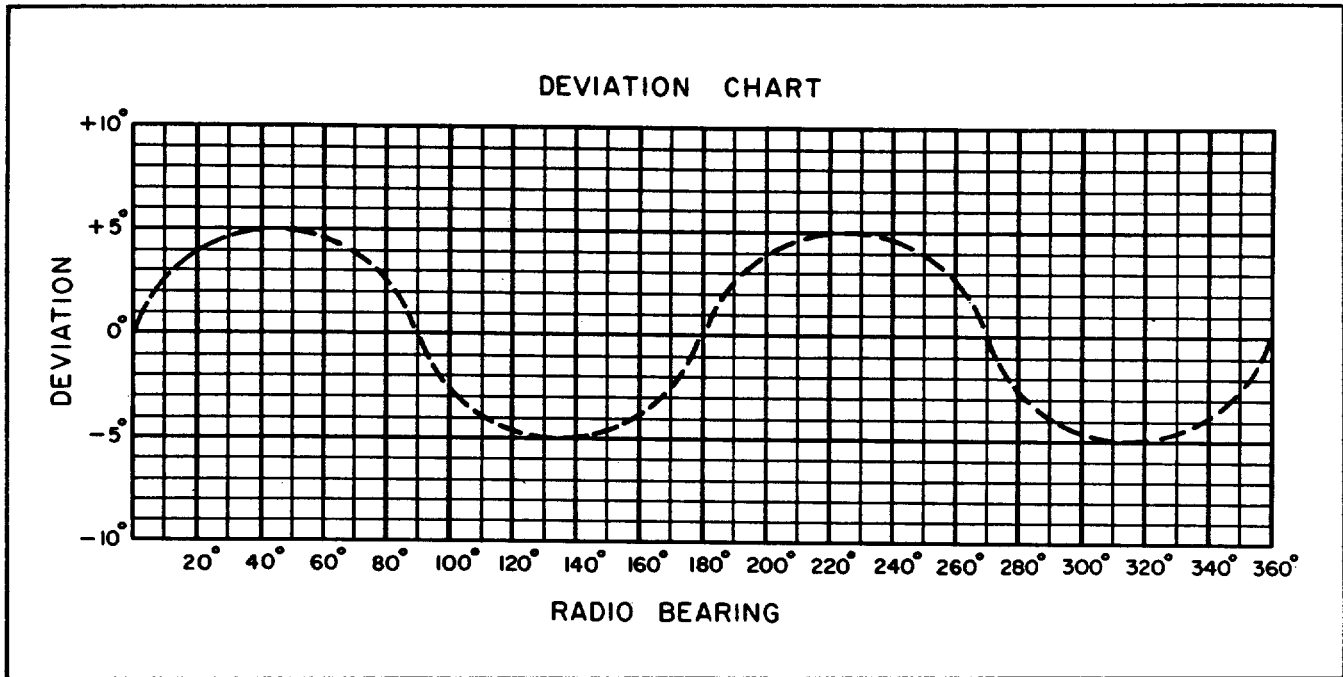

Figure 5. Example Deviation Chart

DEVIATION CHART to be plotted for each individual craft

Batteries. To replace batteries unscrew round covers from rear of RDF-10 as shown in figure 6.

Note direction and type of batteries as they are removed. The RDF-10 is furnished with six size "C" flashlight or radio cells of the common "Zinc" type. The polarity of the cells must be observed.

The condition of the batteries should be checked every 30 days. The batteries should be removed when it is expected that the RDF-10 will be stored or inactive for one week or more.

A loss in output can generally be attributed to low battery voltage. The expected battery life will be between 250 and 500 hours.

CAUTION:

DO NOT REMOVE TRANSISTORS WITH POWER "ON".

REMOVE BATTERIES WHEN THE UNIT IS TO BE STORED FOR ONE WEEK OR MORE.

CAUTION

INSERT (6) "C" SIZE BATTERIES WITH CAPS FACING REAR OF RECEIVER AS SHOWN BELOW

BATTERIES LISTED BELOW MAY BE USED IN YOUR RDF-10

BURGESS	NO. 1 (1.5V)
RCA	NO. VS035 (1.5V)
EVEREADY	NO. 935 (1.5V)
RAY-O-VAC	NO. 1-LP (1.5V)

(OR EQUIVALENT)

Figure 6. Battery Replacement



The following information is furnished for the use of qualified service personnel only.

ALIGNMENT

SET-UP

1. Attach Test Loop to Signal Generator.
2. Connect A.C. VTVM to Speaker Lugs.
3. Place set on speaker side so that the Antenna Loop Stick is at right angles to the Test Loop and approximately 19" from center to center.

NOTE: Figures 7, 8, 9 show coil and trimmer locations. Figure 10 indicates method of stringing dial cord.

ALIGNMENT

Intermediate Frequency

Set Band Switch to broadcast and rotate dial to .55 mc (550 Kc). Turn Sensitivity to half on position. Turn volume CW fully clockwise.

Set signal generator for 455 Kc with 30% modulation and reduce signal generator input as the IF transformers are peaked until a clear audible signal is heard for best peaking of the IF transformers and a peak is read on the VTVM.

Radio Frequencies

The same set-up is used for aligning the "front end" as was used to align the IF strip.

Beacon Band

1. Set dial to 190 Kc (.19 mc)
2. Feed 190 Kc from signal generator.
3. Adjust T109 until signal is audible.
4. Reduce signal generator output while peaking T108, 109, T103.
5. Set dial to 400 Kc (.4 mc)
6. Feed 400 Kc from generator.
7. Adjust C121 until signal is audible.
8. Reduce signal generator output while peaking C119, C121, C105.
9. Repeat above steps until there is no interaction between settings.

Broadcast Band

1. Set dial and signal generator to 535 Kc (.535 mc).
2. Adjust T107 until signal is audible.
3. Reduce signal generator output while peaking T107.
4. Set dial and signal generator to 1600 Kc (1.6 mc) and adjust C118 for audible signal.
5. Reduce signal generator output while peaking C118.
6. Repeat above step until no interaction exists.
7. Set dial and signal generator to 600 Kc (.6 mc) and peak mixer coil T106 and RF coil T102 for best signal.
8. Set dial to 1500 Kc (1.5 mc) and check final peaking of mixer and RF trimmers C116 and C104.

Marine Band

1. Set dial and signal generator to 1700 Kc (1.7 mc) and adjust oscillator coil T105 for best signal out.
2. Set dial and signal generator to 3500 Kc (3.5 mc) and adjust C114 for best signal out.
3. Repeat above steps until there is no interaction.
4. Set dial and signal generator to 1800 Kc (1.8 mc) and adjust mixer coil T104 and RF coil T101 for best signal out.
5. Set dial and signal generator to 3200 Kc (3.2 mc) and adjust mixer trimmer C111 and RF trimmer C103 for best signal out.

CAUTION: Do not remove transistors with power "ON".



PARTS LIST RDF-10

SCHEMATIC DESIGNATION	DESCRIPTION	HAMMARLUND PART NO.
CAPACITORS		
C101, C102 C103 thru 105, C111, C114, C116, C118, C119, C121 C106, C109, C110, C112 C115, C122, C123, C131 C134, C135, C143, C145, C146 C107 C108, C136 C113 C117 C120 C124, C126 thru C130, C144 C125, C137, C140 C132, C139 C133, C147 C138, C142 C141	Fixed Ceramic .005 mfd. 30V Trimmer Assembly Fixed Ceramic .1 mfd. 30V. Main Tuning Electrolytic 10 mfd. 10V. Fixed Mica 300 mmfd. ± 2% Fixed Mica 400 mmfd. ± 2% Fixed Mica 1500 mmfd. ± 2% Fixed Ceramic .02 mfd. 30V Electrolytic 50 mfd. 10V Fixed Ceramic .2 mfd. 30V Fixed Ceramic .01 mfd. 100V. Fixed Ceramic .05 mfd. 30V Electrolytic 100 mfd. 10V	M23034-36 M26565-1 M23034-37 P26518-1 K23093-1 K23006-91 K23006-92 K23027-20 M23034-39 K23093-2 M23034-40 M23034-44 M23034-38 K23093-4
RESISTORS (ALL RESISTORS ARE ½ WATT 10% EXCEPT WHERE NOTED)		
R101 R102, R104 R103, R107 R106, R128 R108, R117, R133 R109 R110, R122, R137 R111, R115 R112 R113 R114 R116, R127, R131 R118 R119 R120, R130 R121, R132 R134 R129, R135, R136 R124, R125, R126 R105 R123	470K 27K 4.7K 1.2K 2.7K 2.2K 5% 100 1K 180K 15K 3.3K 68K 150 100K 10K 470 33 10 680 Sens. Control 25K ± 20% Volume Control 10K ± 20%	K19309-113 K19309-83 K19309-65 K19309-51 K19309-59 K19309-271 K19309-25 K19309-103 K19309-103 K19309-77 K19309-61 K19309-93 K19309-29 K19309-97 K19309-73 K19309-41 K19309-13 K19309-1 K19309-45 K15368-8 K15378-5
TRANSISTORS & SEMI-CONDUCTORS		
Q101, Q104 Q102 Q103 Q105 Q106 Q107, Q108 Q109, Q110 CR101 CR102	2N1108 2N1107 2N1109 2N293 2N169 2N192 2N188A 1N295	K40766-1 K40767-1 K40768-1 K40769-1 K40770-1 K40771-1 K40772-1 K41209-1 K41210-1
TRANSFORMERS		
T101 T102 T103 T104 T105 T106 T107 T108 T109 T110 T111 T112 T113 T114	Antenna, Marine Antenna, Broadcast Antenna, Beacon Mixer, Marine Oscillator, Marine Mixer, Broadcast Oscillator, Broadcast Mixer, Beacon Oscillator, Beacon 455 Kc. I.F. Input 455 Kc. I.F. Input 455 Kc. I.F. Output Audio Driver Audio Output	K26522-1 K26523-1 K26524-1 K26525-1 K26526-1 K26527-1 K26528-1 K26529-1 K26530-1 K26531-1 K26531-1 K26535-1 K26536-1 K26537-1
SWITCHES		
S101, S103 S102	Slide Switch Band	K52015-1 M26533-1
SPEAKER		
SP101	3.2 ohms	M26534-1
SPECIAL ASSEMBLIES		
J101 J102	Dial Cord Assembly Meter (Null Indicator) Loop Antenna Assembly Whip Antenna (Sense) Knob Loop Jack Phone Jack	K26573-G1 K26556-1 P26545-G1 M26519-1 K26546-1 K35608-6 K35608-1

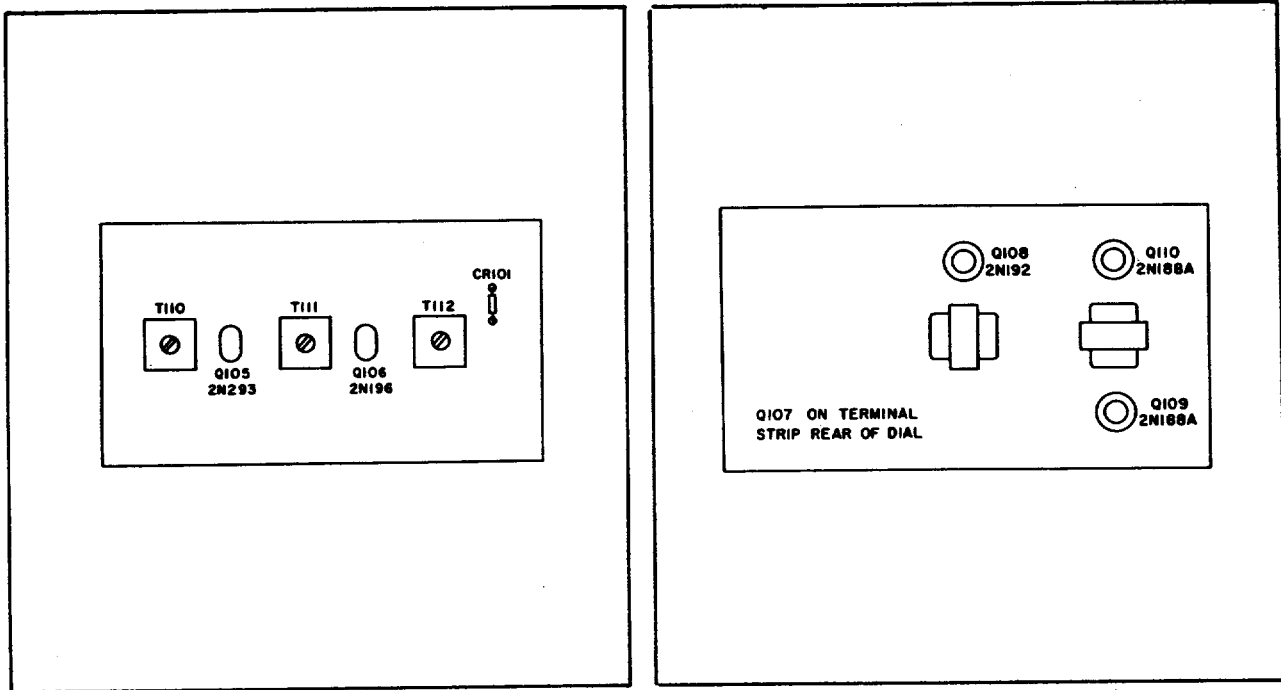

Figure 7. IF Transformer & Transistor

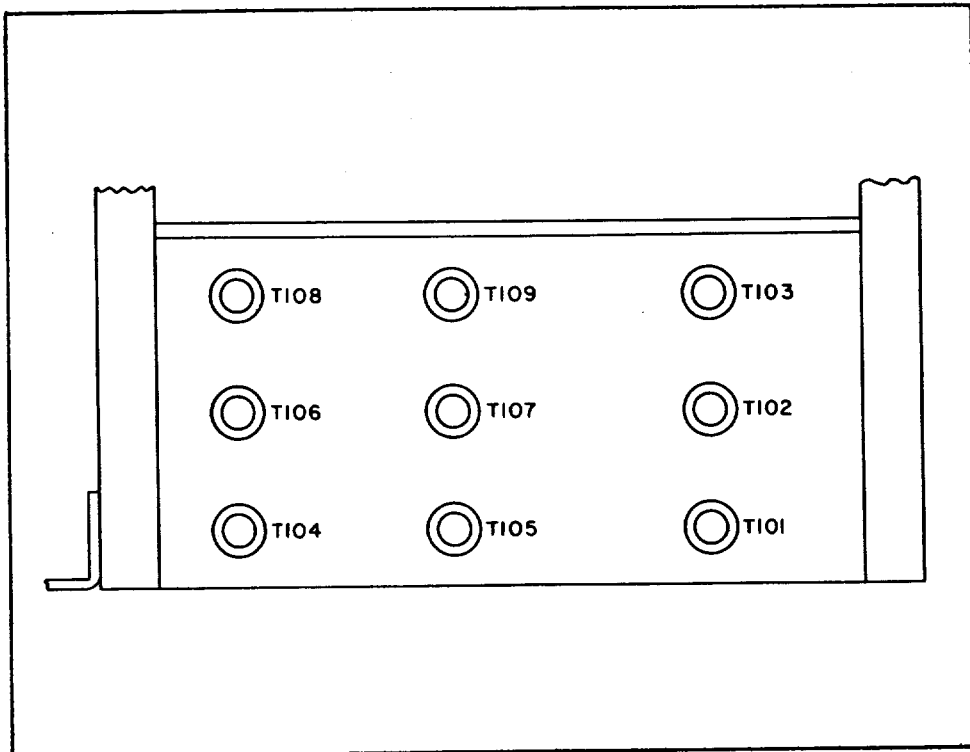

Figure 8. RF Coil Location

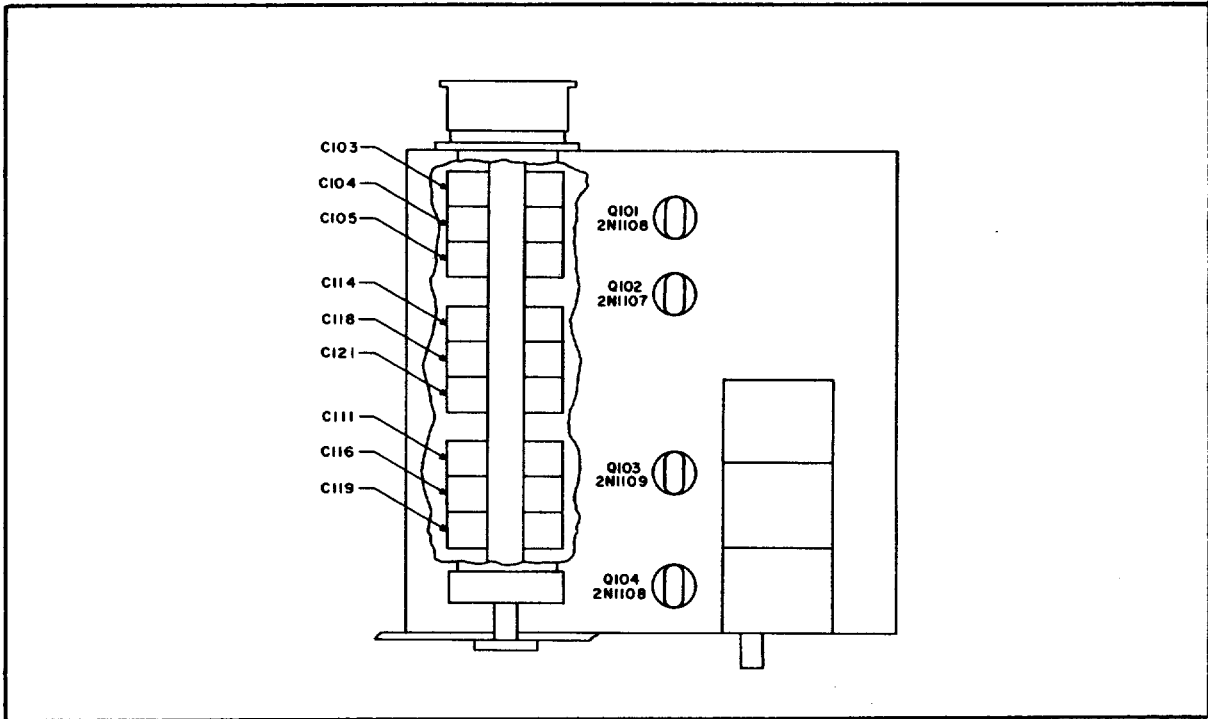

Figure 9. RF Trimmer Location

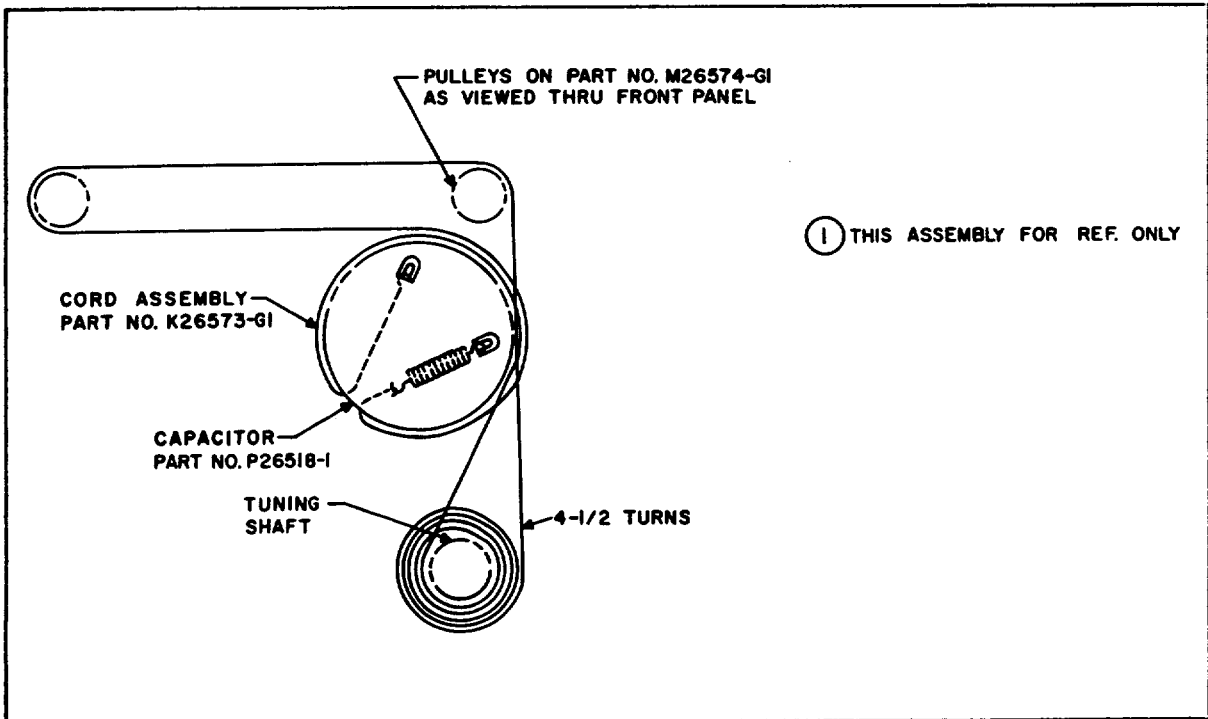
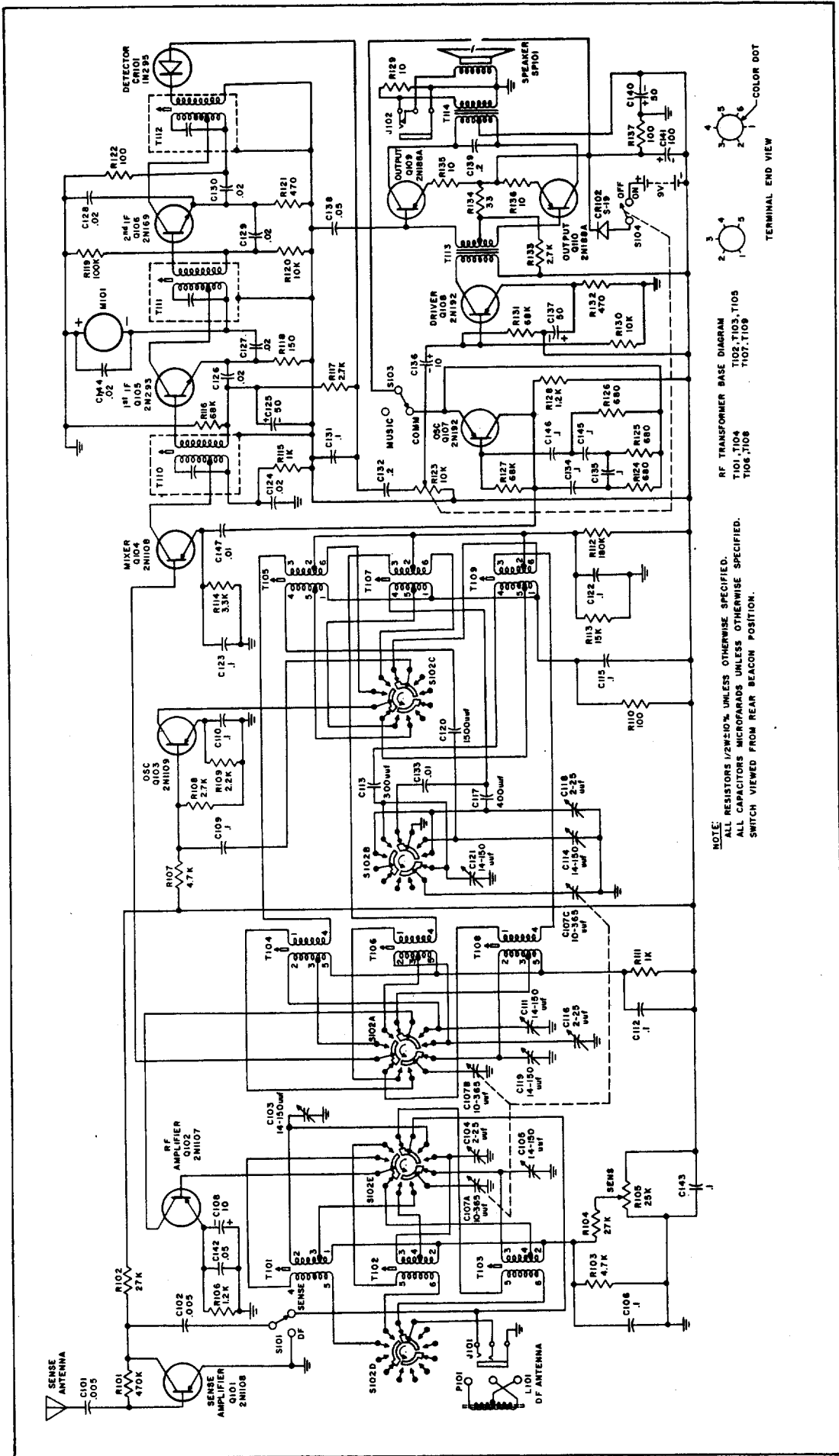

Figure 10. Dial Cord Assembly



NOTE:
 ALL RESISTORS 1/2W±10% UNLESS OTHERWISE SPECIFIED.
 ALL CAPACITORS MICROFARADS UNLESS OTHERWISE SPECIFIED.
 SWITCH VIEWED FROM REAR BEACON POSITION.

RF TRANSFORMER BASE DIAGRAM
 T101, T104
 T102, T103, T105
 T107, T108
 T109

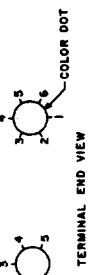

Figure 11. Schematic Diagram

THE HAMMARLUND MANUFACTURING COMPANY, INC.

Standard Warranty

The Hammarlund Manufacturing Company, Inc., warrants this equipment to be free from defects in workmanship and materials under normal and proper use and service for the uses and purposes for which it is designed, and agrees to repair or replace, without charge, all parts thereof showing such defects which are returned for inspection to the Company's factory, transportation prepaid, within a period of 90 days from date of delivery, provided such inspection discloses to the satisfaction of the Company that the defects are as claimed, and provided also, that the equipment has not been altered, repaired, subjected to misuse, negligence or accident, or damaged by lightning, excessive current or otherwise, or had its serial number or any part thereof altered, defaced, or removed. Tubes shall be deemed to be covered by the manufacturer's standard warranty applicable thereto, and such items shall be and are hereby excluded from the provisions of this warranty. Pilot lamps and fuses are not guaranteed for length of service.

Except as herein specifically provided, no warranty, express or implied, other than that of title, shall apply to any equipment sold hereunder. In no event shall the Company be liable for damages by reason of the failure of the equipment to function properly or for any consequential damages.

This Warranty is valid for the original owner of the equipment, and is contingent upon receipt of the Warranty Registration Card by the Company. No equipment shall be returned to the factory for repairs under warranty unless written authorization is obtained by the Company, and the equipment is shipped prepaid by the owner. The Company maintains Authorized Service Stations, names and locations of which will be sent upon request of the owner.

The Hammarlund Manufacturing Company, Inc.
460 West 34th Street
New York 1, N.Y.

